

系统存储器自举模式所需的硬件包含任何相关电路、开关或跳线，它们能够使BOOT0引脚保持高电平，同时将选项字节（起始地址为0x1FFFF800）中的nBOOT1位置1。

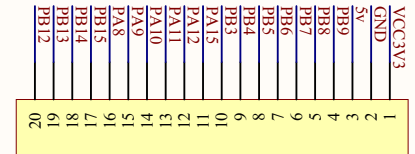
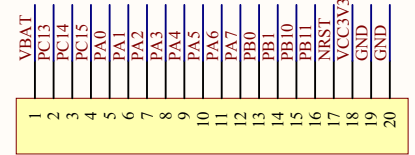
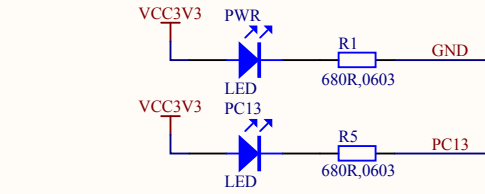
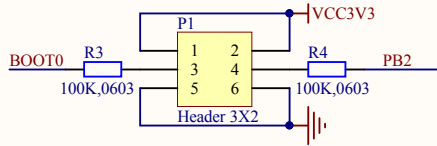

对外端子

源地工作室<http://vcc-gnd.taobao.com/>

论坛地址：<http://www.vcc-gnd.com/>

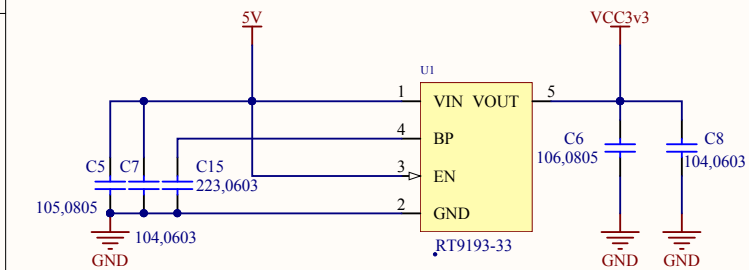

电源 (5V-->3.3V)

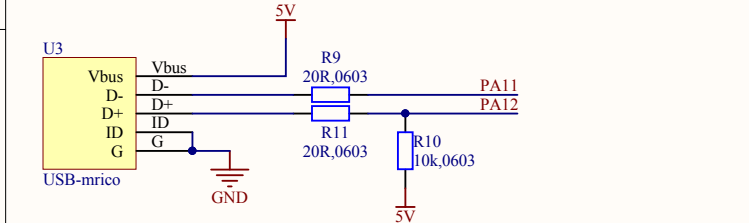

USB电路

J-Link OB接口

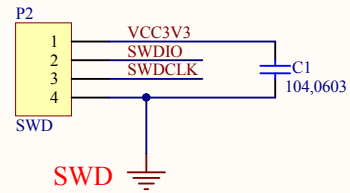

MCU

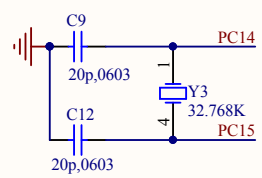
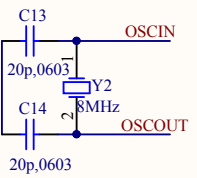
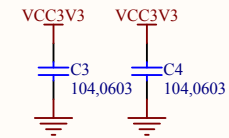
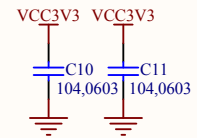
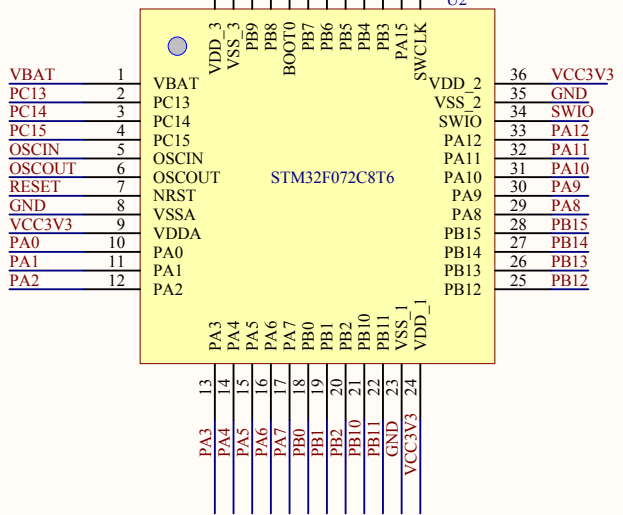

Title			STM32F072C8T6核心板原理图		
Size	Number	Revision			
A4	源地工作室www.vcc-gnd.com				
Date:	2017/4/28	Sheet of			
File:	E:\工作\STM32F072C8T6.SchDoc	Drawn By:			